

QUALITY MANAGEMENT SYSTEM ISO 9001:2008

**ATE**  
ALPHA TECHNICAL EDUCATION

Campus: Delhi-NCR



# ALPHA PARAMEDICAL INSTITUTE

An Autonomous Institution Run by: "Alpha Technical Education"  
Reg.Under Trust Act 1882 Central Govt. of India  
Registered Trade mark Govt. of India Regd.No.2030784/2030785



Department of Labour  
Government of National Capital Territory of Delhi  
Registration No. : 2018054501



Ministry of MSME, Govt. of India  
Micro, small medium Enterprises  
Registration No.UDYAM-DL-08-0024125

[www.ate.ind.in](http://www.ate.ind.in) | [www.apmc.ate.ind.in](http://www.apmc.ate.ind.in)

Sangai International University

UGC-AIU RECOGNISED

|B.P.T|B.N.Y.S.|

|MD NATUROPATHY|

|CMS-ED|

ASSOCIATED WITH VARIOUS UGC RECOGNISED UNIVERSITY  
(ADMISSION & COACHING CENTRE)

**LEADER IN PARAMEDICAL EDUCATION**

Courses	Index	Pages
1. About Naturopathy .....		2
2. Message from Director .....		3
3. About Alpha Technical Education .....		4
4. Medical career Plan .....		5
5. CMS ED .....		6
6. Naturopathy and Yoga programme.....		7
7. BNYS .....		8-9
8. MD(Naturopathy) .....		10
9. DNYS .....		11
10. Master In Yoga (M.A).....		12
11. Certificate in Yoga .....		13
12. Paramedical Department .....		14-18
• Medical Lab Technology .....		15
• Bachelor of Medical Lab Technology (B.M.L.T) .....		16
• Diploma in Medical Lab Technology (D.M.L.T) .....		17
• Certificate Course In Medical Lab Technology (C.M.L.T) .....		18
13. Physiotherapy Department .....		19-24
• Master of Physiotherapy Technology (M.P.T) .....		20-21
• Bachelor of Physiotherapy Technology (B.P.T) .....		22
• Diploma in Physiotherapy Technology (D.P.T) .....		23
• Certificate in Physiotherapy Technology (C.P.T) .....		24
14. Radio Imaging Technology .....		25-31
• Master of Radio Imaging Technology (M.R.I.T) .....		26
• Bachelor of Radio Imaging Technology(B.R.I.T) .....		27-28
• Diploma in Radio Imaging Technology (D.R.I.T) .....		29-30
• Certificate in Radio Imaging Technology (C.R.I.T).....		31
15. Pharmacy Department .....		32-37
• Master of Pharmacy (M.Pharma) .....		33-34
• Bachelor of Pharmacy (B.Pharma) .....		35-36
• Diploma in Pharmacy (D.Pharma) .....		37
16. Nursing Department .....		38-41
• M.S.C Nursing .....		39
• B. Sc Nursing .....		40
• G.N.M .....		41
17. Admission form .....		42-43

## **CHANGE THE NATION FOR UNIVERSAL CURE METHOD ,BECOME A HEALTHY LIFE CURE BY YOGA & NATUROPATHY,AVOID THE DRUGS GET THE HEALTHY LIFE.**

**Naturopathy** is centered on the body's own healing ability, and thus promotes self-cleansing, repair and healing. Focusing on the immune, hormonal, nervous and detoxification/elimination systems of the body can achieve this process. Once these systems are in balance, the body can once again achieve homeostasis.

**Naturopathy** practioners, then, focus on and work closely with the patient's own unique set of symptoms, reactions and status – the treatment protocols are highly personalised. The patient's own biochemistry, biomechanics and emotional predispositions are harnessed to combat illness.

**A career in naturopathy** offers ample opportunities to the practitioner for earning money as well as reputation. In India there are few colleges on naturopathy offering courses at various levels – diploma, undergraduate and postgraduate.

**Career Prospects Naturopathy** is often practiced in combination with other forms of alternative medicines such as Reiki, homoeopathy, acupuncture etc. Much of the advice of naturopaths is sound, e.g., exercise, quit smoking, eat lots of fresh fruits and vegetables, practice good nutrition, etc.

In India naturopaths are appointed in government as well as private hospitals and health centres. They can also start their own venture where there is high density of population. Naturopathy is getting increasingly popular in all countries across the globe, including India, among people who wish to escape the various side effects and symptoms caused by the allopathic system of medicine. Hence the scope of employment in this sphere is broadening.

Who should take up the Naturopathy and yoga training in naturopathy?

In the past few years life become a machine while men converted himself as slave of money and fast life. Now a days self protection should be main object for each and every people of world. Coronavirus disease (COVID-19) Pandemic has been grasped the whole world. There is not any effective medicine to cure it. Once you develop your Immunity better to cure corona or like other kind of disease. Simply yoga training is essential for everybody.it gives you perfect & healthy long life. It's not only a course of pranayam & anulom vilom Is essential or sanjeevini for every body. Now if you think about carrier in Naturopathy & yoga there is bright future also is having Amazing opportunity either in private or govt. both options are available . Every state or Central govt. has been given lots of vacancies in the school as SARIRIK CHIKITSAK (YOGA TRAINER) Package is also High,TGT,PGT profile is based on your qualification.

प्राकृतिक चिकित्सा महाविद्यालय फरीदाबाद हरियाणा

**Enrolled with" SANGAI INTERNATIONAL UNIVERSITY , MANIPUR"  
University Grant Commission Act, 1956 and empowered  
to award degrees in terms of section 2(f) of UGC Act, 1956.**



## Dr kanhaiya kumar jha

Naturopathy Treatment is key to cure the health problems. Naturopathy & yoga learning is a main object how to keep away yourself from diseases. "Right to learn Naturopathy & Yoga Courses", is a strategic initiative, the State made for its citizens to ensure that every Community of the nation could become healthy as a matter of right. The challenges of our population demand increased opportunities on the part of the State and quality supplementary efforts on the part of the Trusted and the other Education imparting bodies.

The escalating costs and the stiff competition of institution based learning excluded a great majority of the potential seekers of higher and professional education in yoga & Naturopathy. The Colleges, the Yoga & Naturopathy Institution and the universities are the special instruments world over geared to make education accessible, off the campuses for career building. These are the cost effective models for pursuing higher and professional education. These need to be encouraged within the parameters of academic standards and other requirements of the degrees, the students pursue.

It is in this context that the Alpha Technical Education has been running Naturopathy and yoga Courses for all the resident, student and for others who can learn & educate the common people how can become healthy with nature elements.

It is our wish and prayer that these initiatives would supplement the ongoing efforts of the State making professional education in yoga & naturopathy accessible and affordable.

I wish the Yoga & Naturopathy from Our University Concern, God's richest blessings

as they endeavors in the same spirit as the University itself to impart and enhance the professional competence of the enrolling students and through them contribute to the process of nation building.

Director

## About Alpha Technical Education

Alpha Technical education ,Distance learning course in south delhi . Alpha technical education offer the best effective Distance learning programme in south delhi associate with various distance education bureau(deb) approved university ,also provides admission consultancy for various regular indian university .We understand the needs of distance learning course is wide for the working professional . Promotion in job must need degree as well skilling knowledge. working people can't take regular class schedule as per college or university, in that situation distance education courses are proved as a boon for professional.Govt. of india also has given RECOGNITION OF PRIOR LEARNING - PMKVY.This is held at employee working places ,also provides certificates as well as Rs.500 for successful passing candidates.alpha technical education play vital role in these types of govt.project. we have worked with many reputed organisation like ONGC,TATA-MOTORS,SVS,NSDC SKILL MINISTRY INDIA.

**EXTERNAL MODE EDUCATION:-** This is private mode of education in which student directly get admission in the university like "Sangai International University" we provides online coaching class for each and every course of syllabus.External Students Registration method is aiming to those students who couldn't continue or complete their education due to various circumstances and debarred taking up whatever jobs were doing. Some who are very hard worker have stabilized their careers but due to lack of graduate or postgraduate can't go ahead. Here is golden chances for those candidates who may be skilled but not a qualified while success might be nightmare.

“External Student” means a Private candidates who has taken admission at Main Campus of the University in any certificate or diploma or degree programme, but study ownself outside the University.It is accordance with section 2(1)(j) and 5(36) of the Sangai International University Act, 2014, provided they are eligible for admission under the Regulation. we also provides regular,part-time ,week-end classes for working candidates.Our responsibility is how to teach the course content

The demand for Distance education is upcoming day by day and most of professional like online education in vacant time after the office schedule. Alpha Technical ladisarai South Delhi Distance education course, provided under Authorized information & admission guidance center is having licence Code from various university where students are looking for admission Many opportunities are waiting for you become graduate professional. Hence, if you are also deciding to pursue your education to complete your break in study in final years exam as credit transfer, you can join Alpha technical education Distance education center in south delhi ladisarai. To get further information, contact us on mb:9313033445.also you can do online registration just click: [http://oms.ate.ind.in/onlineadmission\(corr\).aspx](http://oms.ate.ind.in/onlineadmission(corr).aspx) and our representative would be respond shortly. Top Reasons to Choose Alpha Technical Education Distance education center in ladisarai south delhi. We are committed to offer the best education services Alpha Technical Education Distance education center. We have many happy students who are obtained various degree, diploma or post graduate courses from this institute also placed at good positions in the industry today. we are in the market since 2006.The courses are available on university fixed amount of fee ,we are not charged any extra amount . Emi option also available.

**Existence of Alpha Technical Education distance learning center:**

Basically Alpha technical education is a govt.Trust Registered under trust act central govt. of india.situated at f-321 old m.b. road ladisarai new delhi 30 2nd floor.It has been functioning since 1995.while registered in 2006.Registered head office is in south delhi ladisarai at same place since 2006.provides vocational Training center as well as computer courses and personality development courses. Alpha technical education is authorized University Information and learning center of various distances,private or online education system.

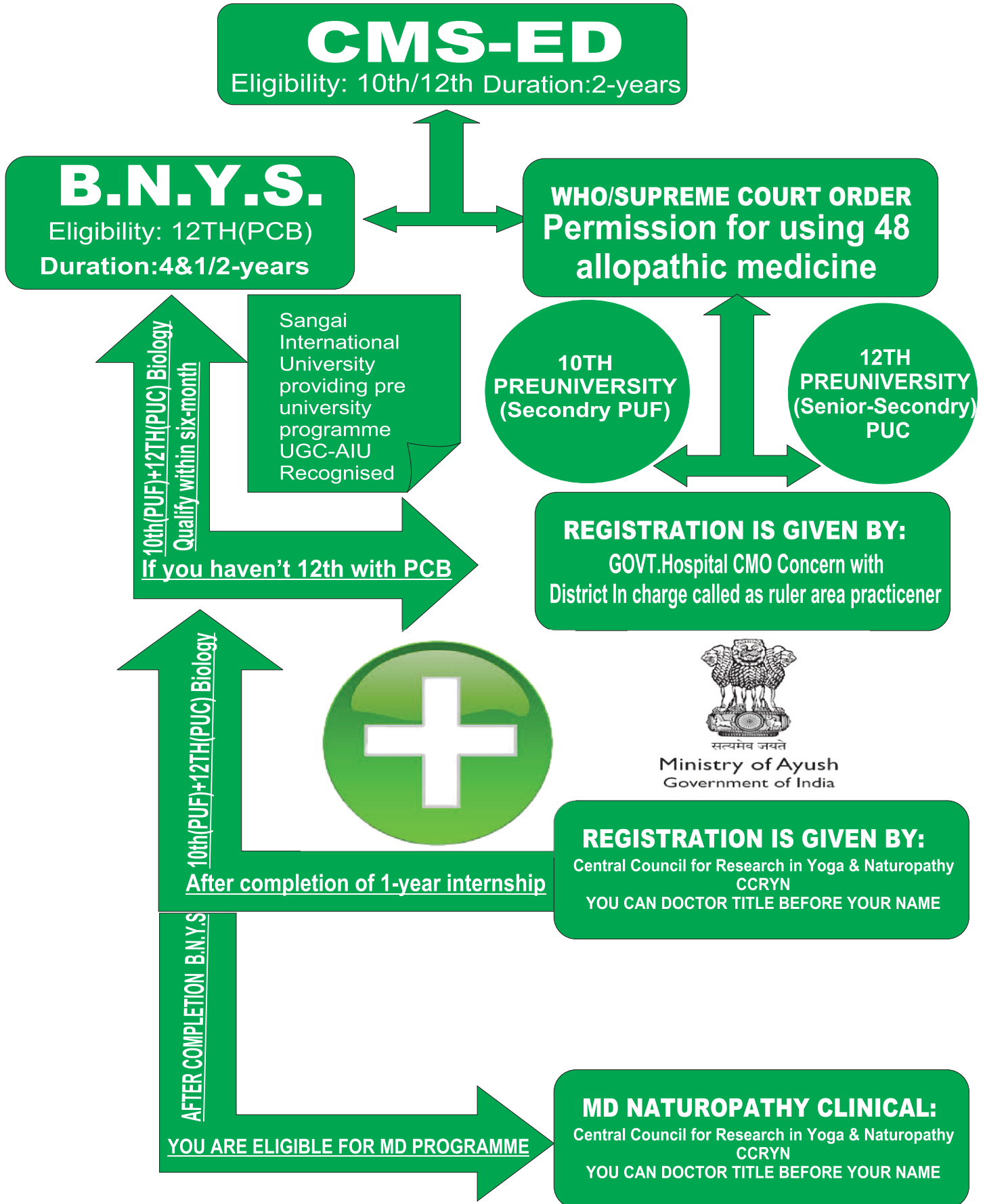

## Programme Overview:

CMS credential is understood as credential in Community Medical Service & essential medicine (CMS & ED). It's a credential for primary Health Care by general allopathic medicines that area unit counseled by world health organization (WHO) for primary health care. The Hon'ble Supreme Court of Republic of India has provided associate degree order that CMS credential holder will give treatment all told diseases together with infection diseases

## Career Perspective:

After completion of CMS credential course anybody will begin his/her practice in geographic region and might use allopathic medicines counseled by world health organization (WHO) for primary health care, as per the judgment of Hon'ble Supreme Court of Republic of India.

## Programme Structure

### Semester-I

PART -1 – Anatomy  
(1) Cell, Tissues, Organ, Structure  
(2) Skeleton System - Structure & Function  
(3) Cardiovascular System  
(4) Muscular System  
(5) Respiratory System  
(6) Digestive System  
(7) Excretory System  
(8) Endocrine System  
(9) Reproduction System  
(10) Nervous System  
(11) Special Senses [Eye, Ear, Nose, Skin

### Semester-II

PART-2- Physiology  
(1) Cell, Tissues - Normal Physiology  
(2) Skeleton System - A.P.L. Function  
(3) Cardiovascular System - Cardiac Cycle Action  
(4) Muscular System - Potential Special  
(5) Respiratory System - Junction Tissues  
(6) Digestive System - Composition  
(7) Excretory System  
(8) Endocrine System  
(9) Reproduction System  
(10) Nervous System

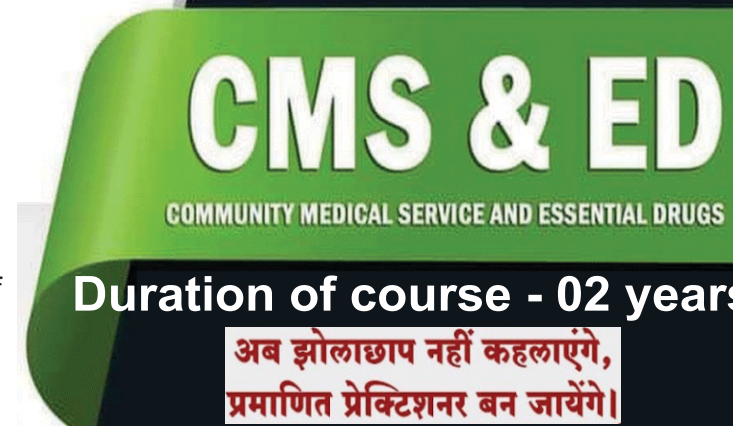

## Eligibility:

Tenth or Higher, Rural Doctors, RMP, BAMS, BHMS, BUMS, BSMS, BEMS, BNYS, BPT, DPT, B.Pharma, D. Pharma, DNYS, Degree/ credential in various Medicines, Paramedical, Nursing, Naturopathy, Dental etc.

## Community Medical Service and Essential Drugs

### Semester-III

PART - 3 - Pathology  
1. General Pathology  
2. Clinical Pathology  
3. Bacteriology  
4. Parasitological  
5. Fungi logy  
6. Helminthological  
7. Applied Pathology  
8. Advance Pathology  
PART - 4 - Health & Hygiene  
1. Food & Nutrition  
2. Community Health & Hygiene  
3. Environment & Sanitation  
4. Home Nursing  
5. First Aid  
6. Ors, Breast Feeding, Healthy Foods etc.  
7. Child Psychology

### Semester-IV

PART - 5 - Medical Jurisprudence  
1. Criminal Courts in India  
2. Indian Legal System  
3. Procedures in Court  
4. Medicals Ethics  
5 Injuries  
6. Rape, Indecent assaults, Battery  
7. Medical Examination & Consent  
PART - 6 - Obstetrics & Gynecology  
(1) Obstetrics - (a) Antenatal Care ( b) Safe Delivery (c) Postnatal Care  
(2) Gynecology - Common Diseases

# Naturopathy & Yoga Programmes

Nature cure or Naturopathy medicine is a form of alternative medicine that works in helping the body to heal itself, using the force of Nature. Its fundamental belief is using the 5 primordial agents of nature that is the earth water fire and the air along with ether.

Naturopathy does not believe in the specific cause of disease and its specific treatment but takes into account the totality of factors responsible for disease such as one's unnatural habits in living, thinking, working, sleeping, relaxing, sexual indulgence etc. It also considers the environmental factors involved which on the whole disturb the normal functioning of the body and lead to a morbid, weak and toxic state.

The treatment is based on the concept that nature has a solution for our problems including health. The human body has the ability to perform the most complicated functions and to cope with various adverse situations.



**Bachelor of Naturopathy & yoga Science(B.N.Y.S.)**

**MD(Doctor of Medicine in Naturopathy)**

**Diploma in Naturopathy &**

**Yoga Science(D.N.Y.S.)**

**Master in yoga(M.A. IN YOGA).**

**Certificate in yoga.(Yoga Teacher Training)**



## Bachelor of Naturopathy & yoga Science(B.N.Y.S.)



The Bachelor of Naturopathy and Yogic Sciences course, popularly known as BNYS, is a 4.5 year long course. The curriculum comprises and integrated study of natural medicine as well as modern methodology of treatment. Aspirants who seek a career in Ayurvedic or Homeopathic medicine can benefit from this course. Apart from medical history and theory, the programme also comprises practical sessions to impart all-round education in the field of naturopathy and yoga. The scope after pursuing this course is bright with people becoming aware of the benefits of yoga and natural medicine.

### **Specialisations:**

Nutrition Therapy  
Herbal/Botanical Medicine  
Homeopathic Medicine  
Acupuncture  
Natural Childbirth

### **Eligibility Criteria:-**

Minimum Qualification Required: 10+2  
(Chemistry, Physics & Biology)  
Minimum Marks Required (Aggregate): 50%



### **First year**

Sanskrit 1  
Physiology  
Computer & Communication Skills  
Principles of Layt  
Biochemistry  
Message of Vedas & Upanishads  
Anatomy  
Introduction & Streams of Yoga  
Sanskrit 2  
Yoga –iya 1  
Yoga –iya 2  
Pathology & Genetics  
Microbiology (T & P)  
Naturopathy - 1  
Biochemistry & Histology  
Naturopathy - 2  
Psychology

**Second year**

Epics and Concept of Dharma  
Diet & Nutrition  
computer & Communication Skills  
Musculo-skeletal System - II  
Nervous System - I  
Yoga Therapy Special Techniques  
Physiotherapy  
Heamatology  
Nervous System - II  
Musculo-skeletal System I  
Patanjala Yoga Sutra I  
Manipulative Therapy

**Third year**

Yoga Therapy in the Light of Bagavad Gita  
Hydrotherapy  
Gynecology & Obstetrics  
Advance Asanas & Kriyas  
Hatha Yoga Texts 1 Hyp & G S  
Patanjala Yoga Sutra II  
Environmental Science  
Acupuncture & Fasting  
Oncology  
Cardiovascular System  
Mud, Acupuncture & Fasting

**Fourth Year:**

Hatha Yoga Texts 2 Hr, SS and Others  
Narada Bakthi Sutra  
Excretory System  
Psychotherapy  
Advance Pranayama, Meditation & Trataka  
Chromo - Magneto Therapy  
Community Medicine & First Aid  
Psychiatry  
Ophthalmology  
Research Methodology  
Reproductive System & Endocrinology  
Geriatrics & Aging

**Fifth Year:**

Karma Yoga Sutras  
Acupressure & Reflexology  
Mind Body Medicine  
Acupressure & Reflexology  
Pediatics  
ENT

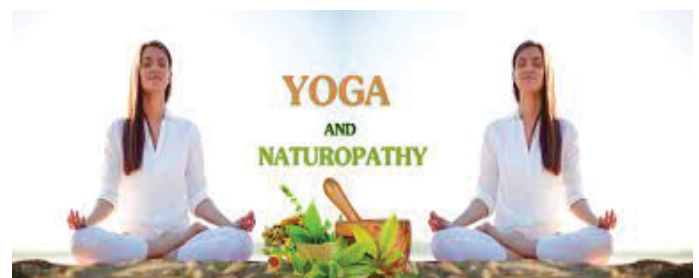



# B.N.Y.S. Medical Degree Course Covers Following Departments of Studies

## About the Department

- About
- Physiology
- Biochemistry
- Microbiology
- Yoga-Department
- Naturopathy
- Pathology
- N. Pharmacological
- Acupressure
- Dietetics & Nutrition

### **Anatomy Department :**

The department of anatomy has required infrastructure as per Central Council for Research in Yoga & Naturopathy (CCRYN Norms:- well equipped practical hall human skeleton , well furnished and equipped laboratories (Gross anatomy and Radiological anatomy lab., Histochemistry lab., Developmental Anatomy lab. The departmental library is having latest 127 text books and journals, seminar room are well equipped and well furnished with latest teaching aids.

### **Physiology Department :**

The department of physiology has highly qualified and experienced teaching faculty as per CCRYN norms. The department is effectively implementing teaching/training programmes for undergraduate and post graduate courses as per CCRYN norms.

### **Yoga-Department :**

“अथ योगानुशासनम्” is the first sutra of Patanjali Yoga Darshan and it has a clear message to us that discipline in thought, speech and action is first step towards the spirituality of the yoga philosophy. In our country, Yoga is a culture which brings us the good health, harmony, peace and skilled mind.

### **N. Pharmacological Department :**

The composition of the department in terms of faculty strength, infrastructure and laborites/equipment is as per CCRYN regulations.

### **Biochemistry Department :**

The aim of the department of biochemistry is to enable undergraduate and postgraduate students to understand, envisage and explain life processes as molecular events and, to apply their knowledge and skills in clinical problem solving and scientific research.

### **Naturopathy Department :**

Naturopathic medicine is defined as a drugless, noninvasive, rational and evidence-based system of medicine imparting treatments with natural elements based on the theories of vitality, toxemia and the self-healing capacity of the body, as well as the principles of healthy living.

### **Acupressure Department :**

Acupressure is an alternative medicine technique similar in principle to acupuncture. It is based on the concept of life energy which flows through "meridians" in the body. In treatment, physical pressure is applied to acupuncture points with the aim of clearing blockages in these meridians.

### **Microbiology Department :**

The department is using modern teaching technologies/resources, special emphasis is being given to interactive teaching/lectures.

### **Pathology Department :**

The department is the first one in the state that established subspecialties with dedicated efforts and commitment of all the faculty and staff. The department is a member of external quality control programme for cytology, coagulation and histopathology.

### **Dietetics & Nutrition :**

The highest quality nutritional care, leading edge nutrition practice, food service & education, innovative business developmental process flow – to patients and staff. The department addresses today's complex nutrition and health issues found across the country and abroad to enhance the quality of life for people and communities.

## (Doctor of Medicine in Naturopathy)

M.D. Naturopathy is a post-graduate-level course. To start with, Yoga is a physical, mental, and otherworldly discipline, beginning in old India pointing the fulfillment of a condition of immaculate profound understanding and quietness while thinking about Super soul. Second, Naturopathy is a type of elective prescription dependent on confidence in vitalism, which places that an extraordinary vitality called essential vitality or indispensable power manages in essence procedures, for example, digestion, propagation, development, and adjustment. The term of the course is three years.

### Eligibility

Qualification for the M.D. course is limited to those holding the MBBS degree. The accreditation must be from a college that is recognized by the Medical Council of India.

### Job Types

Help Ayurvedic Doctor  
Clinical Psychologist  
Research Officer - Naturopathy  
Advisors and Naturopaths  
Yoga Aerobics Instructor

### DURATION : 3 YEARS

#### Paper-I

(Applied basic medical sciences and concept of health & diseases in naturopathy)

#### Paper-II

(Diagnosis using conventional medicine & indicators of diseases process in naturopathy and therapeutic management of disorders through naturopathy)

#### Paper-III

(Diagnosis using conventional medicine & indicators of disease process in naturopathy and therapeutic management of disorders through naturopathy)

#### Paper-IV

(Research methodology and recent advances in naturopathy final dissertation and presentation with viva voce)



भारत सरकार द्वारा प्राकृतिक शिक्षा की मान्यता(S.C.ORDER NO.7407.NO.9/5/445/73):

(D.N.Y.S.|B.N.Y.S.):स्वास्थ्य एवं परिवार कल्याण मंत्रालय भारत सरकार ने आदेश संख्या-

R14015/25/96/-U & (R) (PT)

दिनांक 5 नवंबर 2003 द्वारा प्राकृतिक शिक्षा एवं योग को अन्य पेशियों के सामान मान्यता दी

और इस पैथी में कोर्स किये चिकित्सकों को अपने नाम के साथ डॉक्टर सब्द

का प्रयोग करने का अधिकार दिया ।



## PROGRAMME OVERVIEW:

The Diploma of Naturopathy and Yogic Sciences course, popularly known as DNYS, is a 2 year course. The course of study comprises & study of natural medicine as well as modern methodology of treatment. Any medical degree course seeker who consider a carrier in Ayurvedic or Homeopathic medicine system can also think choices as DNYS medical diploma course. There is both theory & practical session are included in it. The scope after pursuing this course is bright with people becoming aware of the benefits of yoga and natural medicine.

Specialisations:

Nutrition Therapy

Herbal/Botanical Medicine

Homeopathic Medicine

Acupuncture

Natural Childbirth

Eligibility Criteria:-

Minimum Qualification Required: 10+2

(Chemistry, Physics & Biology)

Minimum Marks Required (Aggregate): 50%



## PROGRAMME STRUCTURE

### Year-I

HUMAN ANATOMY

HUMAN PHYSIOLOGY

HUMAN PATHOLOGY

PHILOSOPHY OF YOGA

PHILOSOPHY OF NATURECARE

YOGA CULTURE



### Year-2

BIOCHEMISTRY

HUMAN MICROBIOLOGY

COMMUNITY MEDICINE

HYDRO THERAPY

FUNDAMENTALS OF AYURVEDA

FASTING NUTRITION DIETETICS

PHYSIOTHERAPY



## Programme Overview:

MA in Yoga is a master level course. The full course consists of 2 Years (four semesters). It provides helps to improve health and happiness. The aim of the Yoga Education course to provide the required training to the aspirants who wish to undertake a further career in this field. The course syllabus provides knowledge about the benefits of Yoga to restore the health of people and assist them in leading a fit lifestyle free of ailments. During the study time, candidates learn about the anatomy of the human body, learning of asanas, history of yoga, yoga benefits and so on. The purpose of this course also train and prepare candidates for the exoteric aspects of Yoga making them competent to lead an esoteric lifestyle.

## Eligibility:

The applicant with a minimum of 50% in Graduation with the related subject (under 10+2+3 scheme) from a recognized University.  
Career Prospect:

Therapists  
Yoga Experts  
Programme Director  
Publication Officer (Yoga)  
Job Profile:

Research Officer  
Trainer  
Assistant Research Officer  
Yoga Experts  
Programme Officer  
Yoga Manager  
Therapist  
Publication Officer (Yoga)  
Yoga Instructor

## Course Duration:

Program Full Name	MASTER OF ARTS IN YOGA
Program Level	Degree
Duration of the Program	2 Years
Examination Type	Year
Eligibility:	Graduation
Admission Process	Entrance Exam and Merit Based

## Programme Structure:

Syllabus of Arts as prescribed by various Universities and Colleges.

Paper Code	Subjects of Study
1	Mendelian Genetics
2	Techniques in Cell Biology
3	Cytology
4	Molecular Genetics
5	Cytogenetics
6	Plant Breeding
7	Plant Biochemistry
8	Genetic Engineering
9	Plant Biotechnology
10	Environmental Genetics
11	Modern Methods in Crop Breeding
12	Population Genetics
13	Developmental Genetics
14	Biosystematics
15	Elective Papers
16	Biophysics
17	Applied Palynology
18	Plant tissue culture
19	Transgenic
20	Biotechnology
21	Phytochemicals
22	Plant Cell Culture Technology



## Certificate Course in Yoga

### Aim of Certification

The aim is to produce Yoga professionals such that an ATE certified professional will have minimum / basic common standards of Yoga knowledge and expertise irrespective of which institute he or she is certified from. These standards will become the hallmark of Yoga all over the world.

### How will it benefit the member?

It is advantageous for individuals to get certified under this scheme of ATE because ATE will maintain a portal on its website detailing the list and individual details of certified Yoga professionals under this scheme. This will provide more job and service opportunities.

What is the Role of Alpha Technical Education? will provide the Syllabi for the Various Courses and Accredited Member Institutes for conducting the courses.

Certificates once issued by the Member Institutes to candidates on successfully completing the Courses will be permanent. ATE reserves the right to and will conduct audit checks on the Courses to be conducted by the Member Institutes.

Eligibility – 10th Std & 18 Years of Age

Duration – 200 Hours

Practical : Theory = 60 : 40 I.E. 120 Hours: 80 Hours

Minimum Contact Hours = 80% IE. 160 Hours

Practical – Total Contact hours = 96 Hours



**SANGAI  
INTERNATIONAL  
UNIVERSITY**

ESTABLISHED BY THE ACT OF STATE GOVERNMENT AND UNDER UGC  
ACT 2(f) OF UGC ACT 1956, Govt. Of India

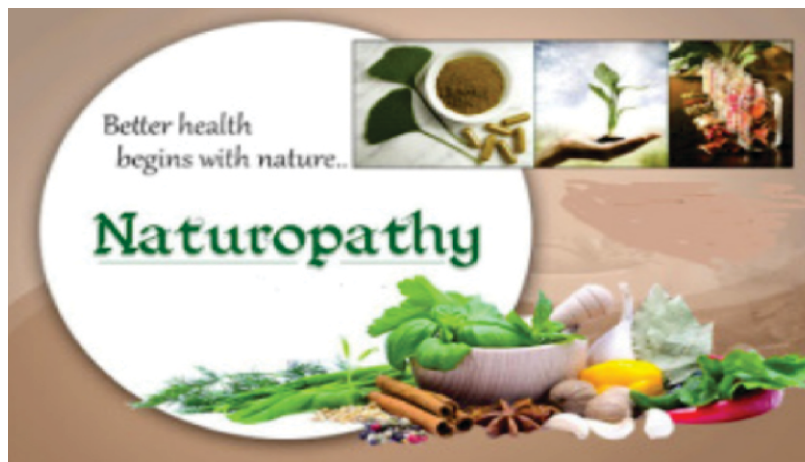



## **Medical Laboratory Technology**

**Master of Medical Laboratory Technology(M.M.L.T.)**

**Bachelor of Medical Laboratory Technology(B.M.L.T.)**

**Diploma in Medical Laboratory Technology(D.M.L.T.)**

**Certificate in Medical Laboratory Technology(C.M.L.T.)**

**Paramedical courses** are medical training courses that are job oriented. Paramedical courses are quite training specific and train the students for real-life medical situations. The significance of paramedical courses has been realized by the increasing need for skilled paramedics in the medical field. This is important to mention that without paramedics the medical field would be crippled.

Paramedics is an amazing field to build a career in the medical field in a short period and budget, unlike the conventional MBBS degree. Paramedical courses are job oriented and present ample employment opportunities.

Another benefit of the Paramedical course is that there are options for postgraduate, graduate, diploma, certificate courses that are of varying durations from 3 years to 6 months. One could choose to do a paramedic course at any stage of his/her career even after completion of 10th standard exams.

Some courses also give the benefit of no mandatory science stream in 12th.

Paramedical courses are offered in various colleges all around the country with average admission requirements.

Paramedical courses give the medical field professionals trained in pre-medical emergency treatment, medical assistance, diagnostic technology training, etc.

Paramedics offer a wide range of courses to choose from in different sectors of the medical field.



## Introduction Of Course:

M. Sc in Medical Laboratory Technology (MMLT) is a two-year postgraduate course usually taken up by students who wish to study an advanced course after B.Sc. Medical Laboratory Technology (MLT) / B.Sc. Physiology (Honours) / B. Sc Microbiology (Honours) / B. Sc Biotechnology (Honours) / B. Sc Biochemistry (Honours). The course is covered under semester pattern in sangai international university Manipur. The program covers the basics of preclinical subjects such as Biochemistry, Pathology, Microbiology and Blood Banking. Master in Medical Laboratory Technology (MMLT) teaches the students how to analyze body matters like fluids, tissues and blood and how to perform cell count, chemical analysis and micro-organism isolation. The course shall teach its students in areas like Blood banking, Blood Sample matching, Haematology, Drug Efficacy Tests, Serology, Clinical Chemistry, Immunology, Cytotechnology, Microbiology, Coagulation, Phlebotomy, Urine analysis and Parasitology. Postgraduates of Master in Medical Laboratory Technology (MMLT) course are more polished than a normal laboratory technician performing routine tests under the given conditions.

### Eligibility Criteria:

Candidate must have passed B.Sc. Medical Laboratory Technology (MLT) // B. Sc Biotechnology (Honours) / B. Sc Biochemistry (Honours) or Equivalent B. Sc. from a recognized University.



## Master of Medical Laboratory Technology(M.M.L.T.)

### Semester-II

Metabolic Biochemistry  
Clinical Pathology  
Immunology & Virology  
Blood Banking  
Histopathology & Cytology  
Parasitology & Mycology  
Metabolic Biochemistry Practical  
Clinical Pathology Practical  
Immunology & Virology Practical  
Blood Banking Practical  
Histopathology & Cytology Practical  
Parasitology & Mycology Practical

### Semester-III

Discipline specific specialized Core Courses - Theory (5)  
Discipline specific specialized Core Courses - Practical (2)

## PROGRAM STRUCTURE

### Year-I

#### Semester-I

Physical & Analytical Biochemistry  
Cellular Pathology  
General Microbiology and Bacteriology  
Human Physiology  
Physical & Analytical Biochemistry-Practical  
Cellular Pathology-Practical  
General Microbiology and Bacteriology-Practical  
Human Physiology Practical

#### Semester-IV

Internship and Log Book  
Dissertation

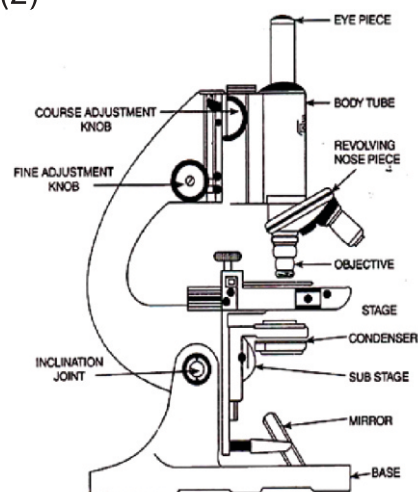

FIG. 15.1. The compound microscope showing its various parts.

# Bachelor of Medical Laboratory Technology(B.M.L.T.)

## PROGRAMME STRUCTURE

### Semester-I

1. Anatomy
- 2 Physiology
- 3 Biochemistry
- 4 Microbiology
- 5 Pathology
- 6 Communication Skills and Personality Development

### Semester-II

- 1 Anatomy
- 2 Physiology
- 3 Biochemistry
- 4 Microbiology
- 5 Pathology
- 7 Fundamentals of Computer Science

### Semester-III

- 1 Biochemistry
- 2 Microbiology
- 3 Pathology
- 4 Environmental Sciences

### Semester-IV

- 1 Biochemistry
- 2 Microbiology
- 3 Pathology

### Semester-v

- 1 Biochemistry
- 2 Microbiology
- 3 Pathology
- 4 Research Methodology and Biostatistics

### Semester-vi

- 1 Biochemistry
- 2 Microbiology
- 3 Pathology
- 4 Final live project



### Introduction Of Course:

The Bachelor of Medical Laboratory Technology (BMLT) also known as Clinical Laboratory Science is a three-year degree course offered by UGC Recognised University supported by Alpha Technical Education. The course primarily deals with the diagnosis, treatment and prevention of diseases through the use of clinical laboratory tests. The program teaches students the ways to use technological instrumentation in an advanced laboratory setting to diagnose, treat and stop diseases. After the successful completion of the degree program, students become well-equipped with the knowledge and skills required to handle advanced lab equipments and perform accurate laboratory tests.

### Eligibility Criteria:

Sr. Secondary (10+2) with Biology or Life Sciences as one of the subjects with minimum 50% marks.



**PROGRAMME STRUCTURE**

**Year-1**

Basic Anatomy, Physiology and Pathology  
 Basic Microbiology  
 Basic Biochemistry  
 Fundamentals of Computer Science  
 Communication for Professional  
 Basic Anatomy, Physiology and Pathology (P)  
 Basic Microbiology (P)  
 Basic Biochemistry (P)

**Year-2**

Human Anatomy and Physiology – I  
 Medical Microbiology  
 Biochemistry  
 Pathology and Hematology  
 General Principle of Hospital Practice and Patient Care  
 Human Anatomy and Physiology – I (P)  
 Medical Microbiology (P)  
 Biochemistry (P)  
 Pathology and Hematology (P)

**Year-3**

Human Anatomy and Physiology – II  
 Systemic Microbiology  
 Clinical Biochemistry  
 Clinical Pathology, Histopathology and Blood Banking  
 Advanced Techniques and Future Trends in Laboratory Science  
 Human Anatomy and Physiology – II (P)  
 Systemic Microbiology (P)  
 Clinical Biochemistry (P)  
 Clinical Pathology, Histopathology and Blood Banking (P)  
 Hospital Training



**Diploma in Medical Laboratory Technology(D.M.L.T.)**

This program equips the students with basic and advanced skills to diagnose diseases through the use of clinical laboratory tests. The students turn out ready for careers in the diagnostics labs, academics and may set up their own diagnostic labs.

Medical Laboratory Technology, also known as Clinical laboratory science, is an allied health/paramedical profession, which is concerned with the diagnosis, treatment and prevention of disease through the use of clinical laboratory tests. Doctors rely on laboratory technologies to detect, diagnose and treat diseases. The programme covers the basics of preclinical subjects such as Biochemistry, Pathology, Microbiology and Blood Banking. Medical Laboratory Technologists (MLT) do these tests by analyzing body fluids, tissues, blood typing, microorganism screening, chemical analyses, cell counts of human body etc..



Program Code	DMLT(10)	DMLT(10+2)
Duration	3 Years	2 Years
Eligibility Criteria	10	10+2 with PCB/PCM

## Certificate in Medical Laboratory Technology(C.M.L.T.)

### Introduction Of Course:

Certificate Course in Medical Laboratory Technology is a short-term specialization course. For a duration of 3 months to 6 months depending on the institute. Certificate Course in Medical Laboratory Technology concerns the prevention, diagnosis and treatment of diseases through the clinical laboratory test.

Certificate Course in Medical Laboratory Technology course help students to learn how to diagnose, detect, and treat diseases. With this certificate course, students also study the Sampling, reporting, testing, and documentation about the clinical tests.

### Eligibility Criteria:

Students who have completed their 10th/10+2 from the reputed college or from the well-recognized board

### PROGRAMME STRUCTURE

#### First semester

Basic Human sciences  
Computer Application  
Clinical pathology  
Communicative English  
Pathology

#### Second semester

Bacteriology  
Serology  
Practical techniques  
Mycology  
General techniques  
Practical and demonstration will be done on the basis of theory



Medical Lab  
Technology





## What Is Physiotherapy?

Physiotherapy is a health care profession which assists people to restore, maintain and maximize their strength, function, movement, and overall well-being. The terms "physiotherapy" and "physical therapy" mean the same thing and are used interchangeably, as are the terms "physiotherapist" and "physical therapist".

Physiotherapists have in-depth knowledge of how the body works and specialized hands-on clinical skills to assess, diagnose, and treat symptoms of illness, injury and disability. Physiotherapy includes rehabilitation, as well as prevention of injury, and promotion of health and fitness. Physiotherapists often work in teams with other health professionals to help meet an individual's

### Physiotherapy can help you ...

become stronger and more flexible  
increase freedom of movement and mobility  
breathe easier  
reduce pain  
stay active  
prevent injury



### Physiotherapists work in ...

hospitals or acute care facilities  
rehabilitation centres  
long term care facilities  
home care programs  
public health units  
private clinics  
schools  
child development centres  
industry  
recreation centres  
sports clinics and facilities  
universities

**Master of Physiotherapy Technology(M.P.T.)**  
**Bachelor of Physiotherapy Technology(B.P.T.)**  
**Diploma in Physiotherapy Technology(D.P.T.)**  
**Certificate in Physiotherapy Technology(C.P.T.)**

## GOALS OF THE COURSE:

1. To prepare a postgraduate student towards professional autonomy, promote community health through his/her professional practice by referral as well as first contact mode using evidence based practices.
2. To impart research basis to validate techniques during professional practice towards quality care of health care delivery.
3. To develop appropriate professional relationships in multi-disciplinary set up to provide total care of the patients.
4. To update the students with recent advances in the professional practice and provide them opportunities to think, reason and practice towards excellent patients care.
5. To achieve skills in patients handling and professional teaching to other subordinates partly.
6. Inculcate the various skills in patient care handling including communication skills, confidence, clinical reasoning, counseling and research. .
7. Inculcate the quality of patient care handling with ethical values following the bioethical principles, and able to provide rational justification for ethical decisions
8. To train the graduates to execute professional practice through professional ethical code

## ELIGIBILITY

Candidates admitted into the Master of Physiotherapy course should have passed the BPT degree examination of this University or an examination of any other University (on campus full time course) accepted by the authorities of this University as equivalent thereto.

Candidates who have passed BPT , shall obtain migration certificate from the parent university & an eligibility certificate from this University by remitting the prescribed fees along with the application form, before seeking admission

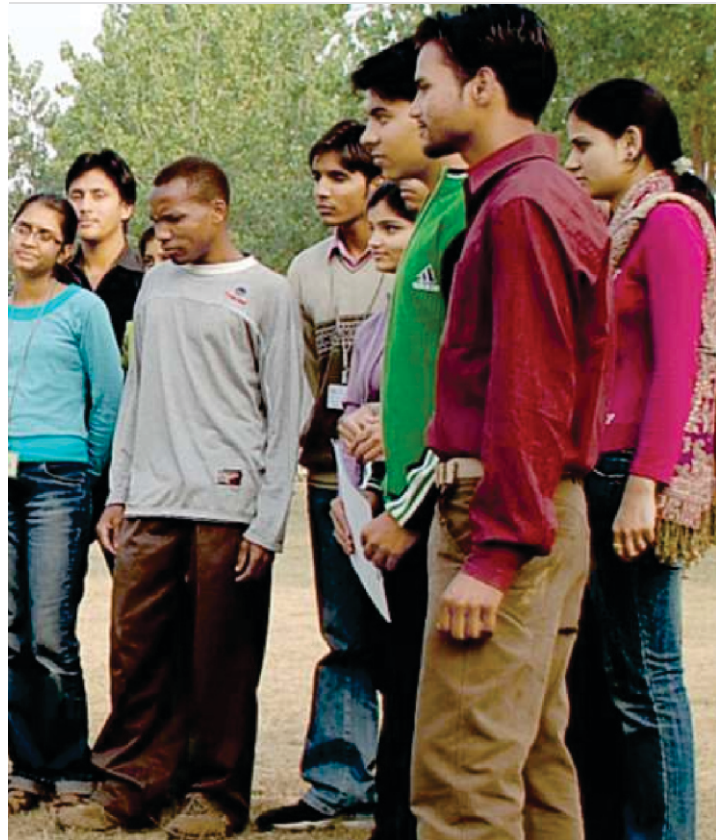

## Master of Physiotherapy Technology(M.P.T.)

The Master of Physiotherapy course is a 2-year fulltime program with 4 semesters leading to the degree that equips the student with analytical, evidence based and Hands on learning skills. The program is generic in nature and has a component of additional learning of one area leading to an elective in that area. Psychosomatic aspects of training are a component through all the elective areas.

## NOMENCLATURE:

The course will be referred to as a Master of Physiotherapy (MPT) with their specialities as:  
Sr. No. Course

A MPT: Orthopedics

B MPT: Neurosciences

C MPT: Cardio – Respiratory Sciences

D MPT: General & Community Based Rehabilitation

E MPT: Paediatrics

F MPT: Musculoskeletal Sciences & Sports

G MPT: Musculoskeletal Sciences & Manual Therapy

H MPT: Musculoskeletal Sciences & Hand Conditions

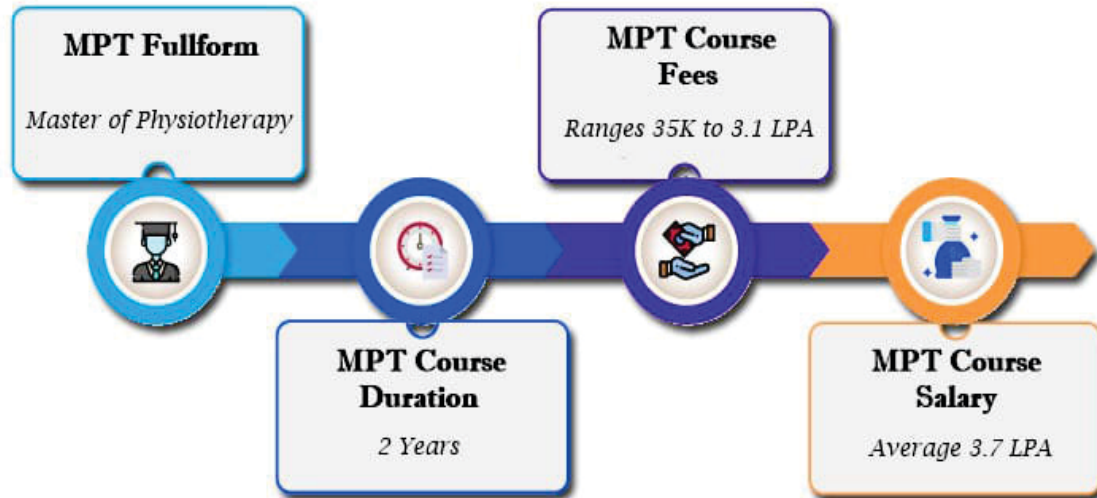

Year-1  
Physiotherapy Practice and Education Technology  
Research Methodology and Biostatistics  
Advanced Electro Therapy & Electro Diagnosis  
Physiotherapeutics-I

Year-2  
Advanced Functional Diagnosis & Manipulative skills  
Applied Biomechanics & Kinesiology  
Exercise Physiology , Health & Fitness  
Physiotherapeutics-II

Year-3  
Elective based Clinical Sciences-I  
Elective based Physiotherapeutics – I  
Elective based Recent advances -I  
Elective based Advance Physiotherapeutics -I  
Year-4  
Elective based Clinical Sciences-II  
Elective based Physiotherapeutics – II  
Elective based Recent advances – II  
Elective based Advance Physiotherapeutics -II

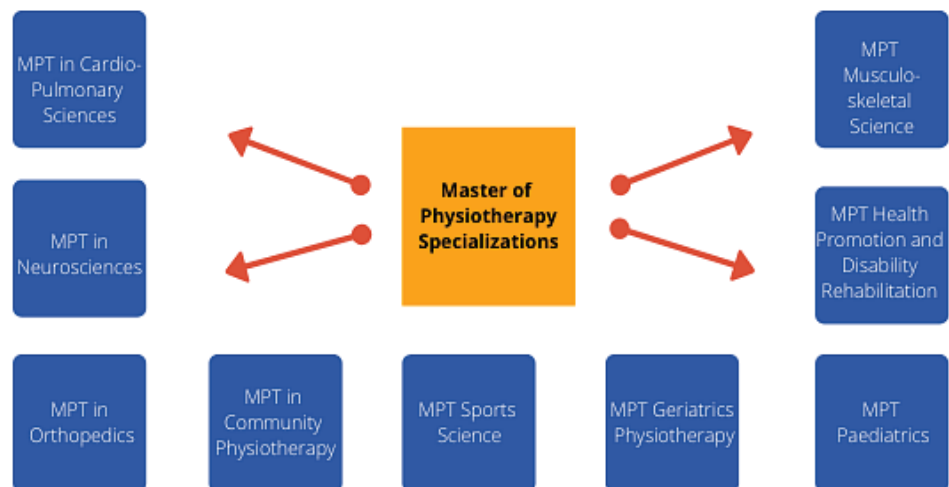

# Bachelor of Physiotherapy Technology(B.P.T.)

## Introduction:

The Bachelor of Physiotherapy (BPT) undergraduate degree course is a 4-year and 6 months (8 semesters & 6 months internship) fulltime program. The program is generic in nature

and has a component of additional learning of one area leading to another area with choice based

study in the final year to focus the career development based on his/her interest.

## Eligibility Criteria (Qualifying Exam)

Pass with 60% aggregate marks in 10+2 (with English, Physics, Chemistry and Biology).

For a candidate, who has not studied English as a subject, the condition of English may be waived off provided the candidate in his qualifying exam has studied in English medium.

(5% relaxation to North East states and Sikkim candidates/ Defence Personnel and their Dependents/ Wards of Kashmiri Migrants)

## Internship:

There shall be six months (24 weeks) of Internship after successfully completing the eighth semester examination for candidates and had been declared to have passed the examination in all the subjects. Internship shall be done in any hospital recognized by the Vidyapeeth. No candidate shall be awarded degree certificate without successfully completing six months of Internship.

The Internship should be rotatory and cover clinical branches concerned with Physiotherapy such as Orthopaedics, Cardiothoracic including ICU, Neurology, Paediatrics, General Medicine, General Surgery, Obstetrics and Gynaecology both at the inpatient and outpatient services. On completion of all postings, the duly completed logbooks will be submitted to the Principal/Head of program to be considered as having successfully completed the internship program

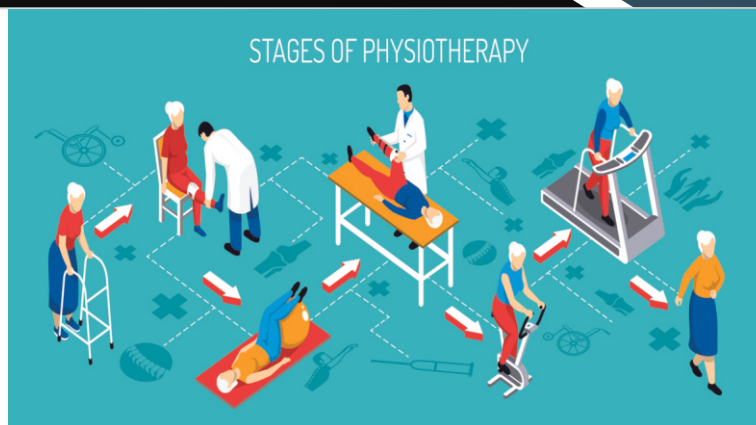

### Semester-1

Anatomy  
Physiology  
Biochemistry  
Basic Nursing  
English

### Semester-2

Biomechanics  
Psychology  
Sociology  
Orientation to physiotherapy

### Semester-3

Pathology  
Microbiology  
Pharmacology  
First Aid and CPR  
Constitution of India

### Semester-4

Exercise Therapy  
Electrotherapy  
Research  
Methodology and Biostatics  
Introduction to treatment  
Clinical observation posting

### Semester-5

General Medicine  
General Surgery  
Orthopedics and Traumatology

### Semester-6

Orthopedics and Sports  
Physiotherapy  
Supervised Rotatory clinical training  
Allied Therapies

### Semester-7

Neurology and neurosurgery  
Community medicine  
Neuro- Physiology  
Community-based Rehabilitation

### Semester-8

Supervised Rotatory clinical training  
Ethics, Administration and Supervision  
Evidence-based physiotherapy and practice



**PROGRAMME STRUCTURE**

**First year**

- 1- Introduction of physiotherapy
- 2- Anatomy
- 3- Physiology
- 4- Elemental nursing
- 5-Elemental biochemistry. Pathology and microbiology
- 6- Hygiene and sanitation
- 7- Nutrition and sanitation
- 8- Biomedical waste management
- 9- First aid
- 10- Disaster management
- 11- Anatomy and physiology as relevant to physiotherapy
- 12- Medical and surgical nursing
- 13-Elementary pharmacology
- 14-Human relations
- 15- Community health nursing and communicable diseases
- 16-Equipment management

**Second year**

- 1-Pathology
- 2- Orthopedics
- 3- Massage manipulation exercise and physical drill and yoga
- 4- Management of medical and surgical emergencies
- 5- Pharmacology
- 6- Medical subjects
- 7- Elementary physics and minor crafts
- 8- Physics of heat and heat therapy
- 9- Physics of light and light therapy
- 10- Physics of electricity and electro therapy
- 11- Hydrotherapy
- 12-Occupational therapy



**Diploma in Physiotherapy Technology(D.P.T.)**

DPT (Diploma in Physiotherapy) course teaches enable clients to achieve optimal independence in physical movement and function, professionals to maximize performance of human movement, instrument evidence-based techniques to manage untidiness of the human body for people of all age groups, provide treatment, rehabilitate those with physical and psychological impairment and maximize clients' useful abilities for healthy lifestyles. It is best Physical Therapy in which involve medical technique of healing which involves physical instruction and restoration, physical movement, force and activities to redress hindrances or distortions in normal bodily movement and physical rehabilitation to normalcy through back rubs and physical exercise and movements. Diploma in Physiotherapy course are taught to provide high-quality holistic care to clients, treat sufferer with physical difficulties resulting from illness, bruise, disabilities or aging, work in a range of settings including hospitals, health centers, private practices and sports clubs, develop relevant technical skills, develop good communication and interpersonal skills and stay .

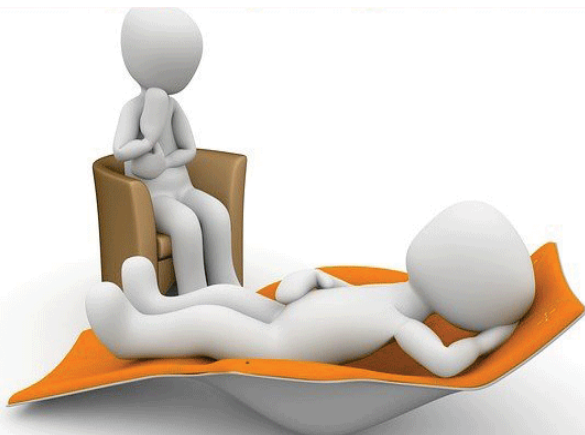

**PROGRAMME STRUCTURE**

**Eligibility Criteria:-**

Minimum Qualification Required: 10+2  
(Chemistry, Physics & Biology)

Minimum Marks Required (Aggregate): 50%

# Certificate of Physiotherapy Technology(C.P.T.)

## Introduction:

The certificate course in Physiotherapy and Yoga therapy aims at providing basic and accurate information about physiotherapy and yoga. The contents of course are designed to impart an integrated understanding to the learners about the issues involved in Physiotherapy and Yoga therapy. The main objective of the programme is to enhance the knowledge and skills of those who are intending to practice or who are already practicing in physiotherapy.

## Eligibility Criteria (Qualifying Exam)

Pass with 60% aggregate marks in 10+2 (with English, Physics, Chemistry and Biology).

For a candidate, who has not studied English as a subject, the condition of English may be waived off provided the candidate in his qualifying exam has studied in English medium.

(5% relaxation to North East states and Sikkim candidates/ Defence Personnel and their Dependents/ Wards of Kashmiri Migrants)



## Physiotherapy working

### 1-Month

Basic Assessment & Evaluation  
Pain Management with Electrotherapy  
Balance & Coordination Training  
GAIT Training, Orthotics & Prosthetics  
Ergonomics & Posture correction

### 2-Month

Foot Condition  
Neck Condition  
Shoulder Condition  
Knee Condition  
Shoulder Condition  
LBP  
SI JointPathology

### 3-Month

SI JointPathology  
Ortho Rehab  
Neuro Rehab  
Stroke Rehab  
Parkinsonism Rehab  
Cardiac Rehab  
Lung Rehab  
COPD Rehab  
Vestibular Rehab  
Paediatric Rehab  
Migraine  
Vertigo  
Advanced Manual Therapy  
Taping  
Sports Injury Rehab  
Geriatric Rehab  
Lymphedema Management

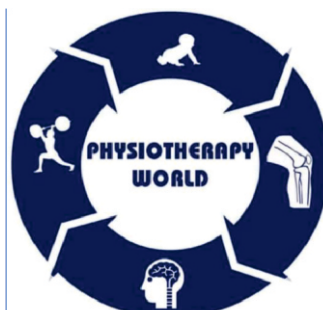



## Radio imaging Technology

(X-Ray+Ultrasound+E.C.G)

Have you ever noticed those guys in hospital gowns who escort patients for an X-Ray, CT-Scan or Chemotherapy? They are the ones who operate the machine for you and later interpret the results for doctors. The word used for them are Radiographers. Radiographers, also known as radiologic technologists, are certified technicians who capture images of organs, bone, and tissue for patient diagnosis.

Radiographers are equipped with the technological skills to handle imaging equipment and the interpersonal skills necessary for patient care. Educational and licensure requirements vary by state and profession, though the completion of a certificate or two-year degree is common for radiologic technologists. Now, India's healthcare sector is on a growth trajectory, the career opportunities for such allied health care workers with expertise in diagnostic science have never been better. Services of diagnostic professionals can be essential for medical treatments and their demand is on the rise.

**Master of Radio Imaging Technology(M.R.I.T.)**

**Bachelor of Radio Imaging Technology(B.R.I.T.)**

**Diploma in Radio Imaging Technology(D.R.I.T.)**

**Certificate in Radio Imaging Technology(C.R.I.T.)**



## Radiology and Imaging Technology



# Master of Radio Imaging Technology(M.R.I.T.)

## PROGRAM OVERVIEW

The quality of medical care has improved tremendously in the last few decades due to the advances in technology, thus creating fresh challenges in the field of healthcare. It is now widely recognized that health service delivery is a team effort involving both clinicians and non-clinicians, and is not the sole duty of physicians and nurses. Professionals that can competently handle sophisticated machinery and advanced protocols are now in high demand. In fact, diagnosis is now so dependent on technology, that allied and healthcare professionals (AHPs) are vital to successful treatment delivery. The program aims to train human resources with requisite skills in the area of medical radiology & imaging technology who can be hired in all kinds of healthcare settings. The program makes use of modern teaching methods and a combination of the theoretical aspects of the subjects with practical reinforcement endow the students with a superior knowledge and enable them to discover their hidden potential, realize the ever importance of hard work and hone their intellectual, analytical and managing skills towards a successful and fulfilling career, supplemented and guided by experienced and quality teaching throughout the course of study.

## ELIGIBILITY FOR ADMISSION

The candidate must have passed 3 Years Bachelor of Medical Imaging Technology or equivalent course from any recognized university in India or abroad with minimum of 50% marks..

## DURATION OF THE PROGRAMME

The programme shall be for 2 academic years (Full time).



## Programme Structure

### FIRST YEAR

- Radiographic Procedure & Pathology
- Instrumentation of Conventional Radiological Equipment
- Principle of Radiographic Exposure
- Instrumentation of specialized Radiological Equipment 6
- Advanced tech & Instrumentation of Ultrasound
- Biostatistics

### SECOND YEAR

- Advanced Tech & Instrumentation of Interventional Radiology Techniques
- Care of Patient in Diagnostic Radiology
- Management of Healthcare Organization
- Radiation Evaluation & Protection in Diagnostic Radiology
- Nuclear Medicine Imaging
- Dissertation on specialization subject (MRI ,CT Scan , Interventional radiology & Nuclear Medicine )

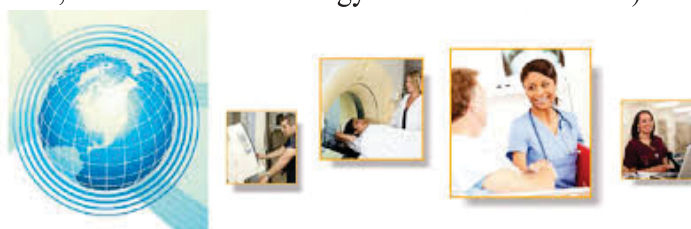
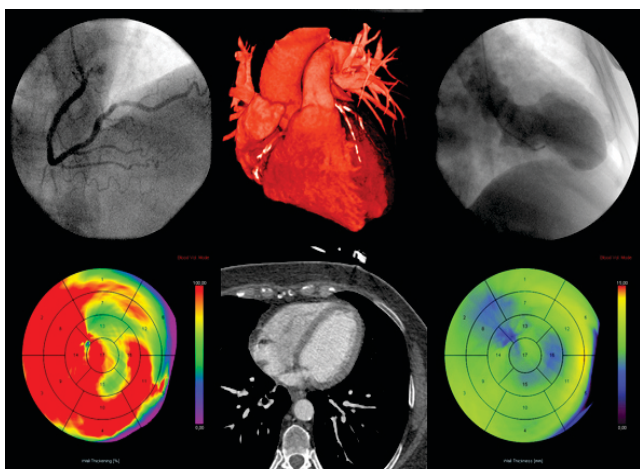

## DURATION OF THE PROGRAMME

The programme shall be for 3 academic years (Full time)./ 6-Semester

## PROGRAMME STRUCTURE

### Semester-1

English Communication  
 English Communication lab  
 National Healthcare Delivery System and Medical  
 Laboratory Science (MLS)  
 National Healthcare Delivery System and Medical  
 Laboratory Science (MLS) - Practical  
 Medical Ethics and Patient Safety Management  
 Medical Ethics and Patient Safety Management Practical  
 Clinical Observation  
 Generic Elective-1  
 (Any one from the List of Generic Elective / Interdisciplinary Courses from other Subjects)  
 Generic Elective -1 (Practical/Tutorial)

### Semester-II

Environmental Science  
 Human Anatomy and Physiology part-1  
 Human Anatomy and Physiology-part-1-Practical  
 Fundamental Physics and Radiological Physics  
 Fundamental Physics and Radiological Physics -Practical  
 Conventional Radiography and equipment  
 Radiographic and Image processing Techniques  
 Radiographic and Image processing Techniques-Practical  
 Clinical Observation  
 Generic Elective-2 (Any one from the List of Generic Elective  
 Interdisciplinary Courses from other Subjects)



## Bachelor of Radio Imaging Technology(B.R.I.T)

### PROGRAM OVERVIEW:

School of Medical and Allied Sciences offers Bachelor In Medical Radiology and Imaging Technology, which is a 4 year degree and is designed for students pursuing studies related to medical imaging. Radiology uses medical imaging to diagnose, treat, and monitor various diseases. Medical imaging includes x-rays, ultrasound, computed tomography (CT), positron emission tomography (PET), and magnetic resonance imaging (MRI), providing a variety of specialization options for potential radiologists. Our Radiology Technology Program prepares students who wish to pursue entry-level positions as Radiology Technologists in hospitals, diagnostic centers, private physician practices, and clinical. Our curriculum provides comprehensive, real-life training that is essential to be successful in diagnostic imaging. We have partnerships with leading acute care facilities, hospitals and diagnostic centers throughout our community that provide excellent clinical training experience. .

### PROGRAM STRUCTURE

#### Eligibility Criteria:-

Minimum Qualification Required: 10+2  
 (Chemistry, Physics & Biology)  
 Minimum Marks Required (Aggregate): 50%

# Bachelor of Radio Imaging Technology(B.R.I.T.) Programme Structure

## Semester-III

Human Anatomy and Physiology including Pathology Part-2  
Human Anatomy and Physiology including Part-2  
Practical  
Pathology  
Clinical Radiography- Positioning Part 1  
Clinical Radiography- Positioning Part 1-Practical  
Modern Radiological & Imaging Equipment  
Contrast & Special Radiography procedures  
Contrast & Special Radiography procedures-Practical  
Clinical Observation  
GE\*\* Generic Elective-3 (Any one from the List of Generic Elective / Interdisciplinary Courses from other Subjects)

## Semester-IV

Physics of Newer Imaging Modalities  
Clinical Radiography Positioning Part 2  
Clinical Radiography Positioning Part 2-Practical  
Modern Radiological & Imaging Techniques including Patient Care  
Quality Control in Radiology and Radiation Safety  
Quality Control in Radiology and Radiation Safety Practical  
Clinical Observation  
GE\*\* Generic Elective-4 (Any one from the List of Generic Elective / Interdisciplinary Courses from other Subjects)

## Semester-v

Cross sectional anatomy and Physiology  
Cross sectional anatomy and Physiology-Practical  
Physics of Advanced Imaging Technology  
Radiographic Techniques of Advanced Imaging Technology  
Radiographic Techniques of Advanced Imaging Technology-Practical  
Regulatory Requirements in Diagnostic Radiology & Imaging, Act and rules, regulations for JCI, NABH, NABHR.  
Clinical Observation

## Semester-vi

Quality Assurance & Radiation Safety (AERB Guidelines) in Diagnostic Radiology  
Quality Assurance & Radiation Safety (AERB Guidelines) in Diagnostic Radiology-Practical  
Hospital Practice & Care of Patients  
Research Methodology  
Medical Law & Ethics  
Clinical Observation  
Seminars, Journal club & Group Discussions 2 0



## PROGRAMME STRUCTURE

### Semester-I

Anatomy  
Physiology  
Biochemistry  
Medical Physics  
English  
Basics of Computers

### Semester-II

Microbiology  
Pathology  
Pharmacology  
Environmental  
Science &  
Community  
Med. Basics of  
Nursing

### Semester-III

Anatomy, Physiology,  
Pathology and Pharmacology  
related to Radiology-Theory

Anatomy, Physiology,  
Pathology and Pharmacology  
related to Radiology –Practical

Radiological Physics and  
Dark Room Techniques  
Theory

Radiological Physics and  
Dark Room Techniques  
Practical

Basic Principles of Hospital  
Management

Comprehensive viva:  
Anatomy, Physiology,  
Pathology and Pharmacology  
related to Radiology

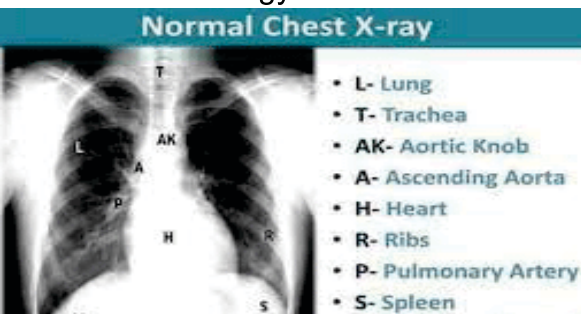

## Diploma in Radio Imaging Technology(D.R.I.T)

### PROGRAM OVERVIEW:

Diploma in radiology and imaging technology is a two year diploma program which aims towards a basic understanding of various aspects of radio diagnostic technology and medical imaging techniques. Students will get through training about the use of radiographic equipment, learn how to position patients to get the best images and learn to critique images. Students will develop knowledge and skills such as anatomy and physiology, examination techniques, patient care, professionalism, radiation safety and protection and x-ray equipment.

### PROGRAM STRUCTURE

#### Eligibility Criteria:-

Minimum Qualification Required: 10+2  
(Chemistry, Physics & Biology)

Minimum Marks Required (Aggregate): 50%

#### DURATION OF THE PROGRAMME

The programme shall be for 3 academic years (Full time)/ 6-Semester

# Diploma in Radio Imaging Technology(D.R.I.T.) Programme Structure



## Semester-III

Human Anatomy and Physiology including Pathology Part-2  
 Human Anatomy and Physiology including Part-2 Practical  
 Pathology  
 Clinical Radiography- Positioning Part 1  
 Clinical Radiography- Positioning Part 1-Practical  
 Modern Radiological & Imaging Equipment  
 Contrast & Special Radiography procedures  
 Contrast & Special Radiography procedures-Practical  
 Clinical Observation  
 GE\*\* Generic Elective-3 (Any one from the List of Generic Elective / Interdisciplinary Courses from other Subjects)

## Semester-IV

Physics of Newer Imaging Modalities  
 Clinical Radiography Positioning Part 2  
 Clinical Radiography Positioning Part 2-Practical  
 Modern Radiological & Imaging Techniques including Patient Care  
 Quality Control in Radiology and Radiation Safety  
 Quality Control in Radiology and Radiation Safety Practical  
 Clinical Observation  
 GE\*\* Generic Elective-4 (Any one from the List of Generic Elective / Interdisciplinary Courses from other Subjects)

## Semester-v

Cross sectional anatomy and Physiology  
 Cross sectional anatomy and Physiology-Practical  
 Physics of Advanced Imaging Technology  
 Radiographic Techniques of Advanced Imaging Technology  
 Radiographic Techniques of Advanced Imaging Technology-Practical  
 Regulatory Requirements in Diagnostic Radiology & Imaging, Act and rules, regulations for JCI, NABH, NABHR.  
 Clinical Observation



## Semester-vi

Quality Assurance & Radiation Safety (AERB Guidelines) in Diagnostic Radiology  
 Quality Assurance & Radiation Safety (AERB Guidelines) in Diagnostic Radiology-Practical  
 Hospital Practice & Care of Patients  
 Research Methodology  
 Medical Law & Ethics  
 Clinical Observation  
 Seminars, Journal club & Group Discussions 2 0



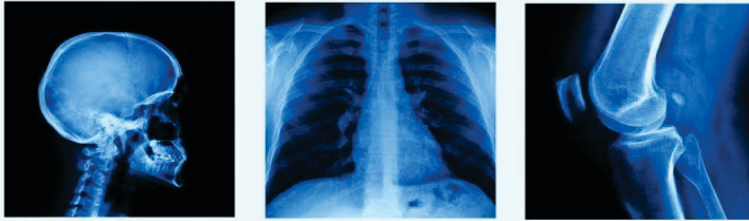

## EXPLORING CAREERS IN RADIOLOGIC TECHNOLOGY



### Certificate in Radio Imaging Technology(C.R.I.T)

#### PROGRAMME STRUCTURE

##### Semester-I

ANATOMY  
PHYSIOLOGY  
PATHOLOGY  
GENERATION AND PROPERTIES OF X-  
RAY  
RADIATION HAZARDS & PROTECTION  
GENERAL RADIOGRAPHY  
COMPUTER SKILLS  
COMMUNICATION SKILL

##### Semester-II

ANATOMY II  
PHYSIOLOGY II  
GENERAL RADIOGRAPHY  
ULTRASOUND  
CT-SCAN  
MRI  
ORGANIZATIONAL BEHAVIOUR  
PERSONALITY DEVELOPMENT

#### PROGRAM OVERVIEW:

Certificate in Radio Imaging Technology is a diploma Radio program. It is the system and procedure used to take pictures of the human body or parts and capacity thereof for clinical purposes (therapeutic techniques looking to uncover/analyze or inspect sickness) or medicinal science including the investigation of ordinary life systems and physiology. Despite the fact that imaging of expelled organs and tissues can be performed for medicinal reasons, such methodology is not, as a rule, alluded to as therapeutic imaging, yet rather are a piece of the pathology.

#### Eligibility Criteria:-

Minimum Qualification Required: 10+2  
(Chemistry, Physics & Biology)  
Minimum Marks Required (Aggregate): 50%

#### DURATION OF THE PROGRAMME

The programme shall be for 1 academic years (Full time)./ 2-Semester



Master of Pharmacy(M.Pharma)  
Bachelor of Pharmacy(B.Pharma)  
Diploma in Pharmacy(D.Pharma)

### Pharmacy courses:

Pharmacy is not just about a drugstore. Those who study pharma degree or pharma diploma courses can also choose research and development of medicine as a career option.

A drug/medicine before being prescribed by a doctor has to undergo tests and approvals. It is tested in a lab, studied for dosage and side effects, only then prescription guidelines are formed. The medicines then undergo clinical trials and only when after studying all the possible effects of the medicine, it is introduced in the market. Pharmacists are a part of the entire process. They are also responsible for introducing a new drug/ medicine to various medical practitioners.

The role of a pharmacist does not end here. They study and keep track of all medicines and products with market surveys by connecting with a medical practitioner and distributors for any side effects, reactions, and allergies, etc. Although, before distribution in a market the medicines are tested in labs because of the complexity and diversity of human beings, different outcomes from the same medicine can occur, therefore, a pharmacy practitioner has to research and develop medicines and prescriptions at multitudes. Pharmacy basically includes everything related to your wellness right from the food you consume to the cosmetics, lifestyle products, health, and chemical products that you use.





## PROGRAMME STRUCTURE

### PHARMACOLOGY (Semester-I)

Modern Pharmaceutical  
Analytical Techniques  
Advanced Pharmacology-I  
Pharmacological and  
Toxicological Screening  
Methods-I  
Cellular and Molecular  
Pharmacology  
Pharmacology Practica  
Seminar/Assignment

### Semester-II

Advanced Pharmacology II  
Pharmacological and  
Toxicological Screening  
Methods-II  
Principles of Drug Discovery  
Experimental Pharmacology  
practical- II  
Pharmacology Practical II  
Seminar/Assignment



## Master of Pharmacy (M.Pharma)

### PROGRAM OVERVIEW:

Masters of Pharmaceutical Sciences (M.Pharm.) is a post-graduate course that can be pursued by a graduate after the completion of an undergraduate degree in the pharmaceutical field. There are different specializations available in M. Pharm. such as Pharmaceutics, Quality Assurance, Medicinal Chemistry, Pharmacology, Pharmacognosy, and many more.

M.Pharm. course duration is 2 year which has 4 semesters including thesis research work. In depth knowledge of pharmacy is provided in the M.Pharm course. Curriculum includes subjects like Drug regulatory Affairs, Pharmacokinetics, Pharmaceutical Manufacturing Technology, etc.

Master of Pharmacy course deals with analyzing, testing, data interpreting and researching of drugs for the treatment of the diseases of human kind. An increased requirement of number of quality professionals in pharmaceutical industry makes this course demanding in pharmaceutical field. The modernization of the Pharmaceuticals has made a massive impact on the development of the medical field

### M.Pharm. Course Eligibility:

Minimum eligibility qualification is graduate degree (B. Pharm.) in the pharmaceutical field, from a recognized university/college, for admission into the Masters of Pharmacy [M.Pharm.] course in any college.

# Master of Pharmacy(M.Pharma) Programme Structure

## PHARMACEUTICAL CHEMISTRY (Semester-I)

Modern Pharmaceutical  
Analytical Techniques  
Advanced Organic  
Chemistry-I  
Advanced Medicinal  
chemistry  
Chemistry of Natural  
Products  
Pharmaceutical  
Chemistry Practical  
Seminar/Assignment

## Semester-II

Advanced Spectral  
Analysis  
Advanced Organic  
Chemistry-II  
Computer Aided Drug  
Design  
Pharmaceutical Process  
Chemistry  
Pharmaceutical  
Chemistry Practical  
Seminar/Assignment



## PHARMACEUTICS (Semester-I)

Modern Pharmaceutical  
Analytical Techniques  
Delivery System  
Modern Pharmaceutics  
Regulatory Affair  
Pharmaceutics Practical  
Seminar/Assignment

## Semester-II

Molecular Pharmaceutics  
(Nano Tech and Targeted  
Advanced  
Biopharmaceutics &  
Pharmacokinetics  
Computer Aided Drug  
Delivery System  
Cosmetic and  
Cosmeceuticals  
Pharmaceutics Practical II  
Seminar/Assignment

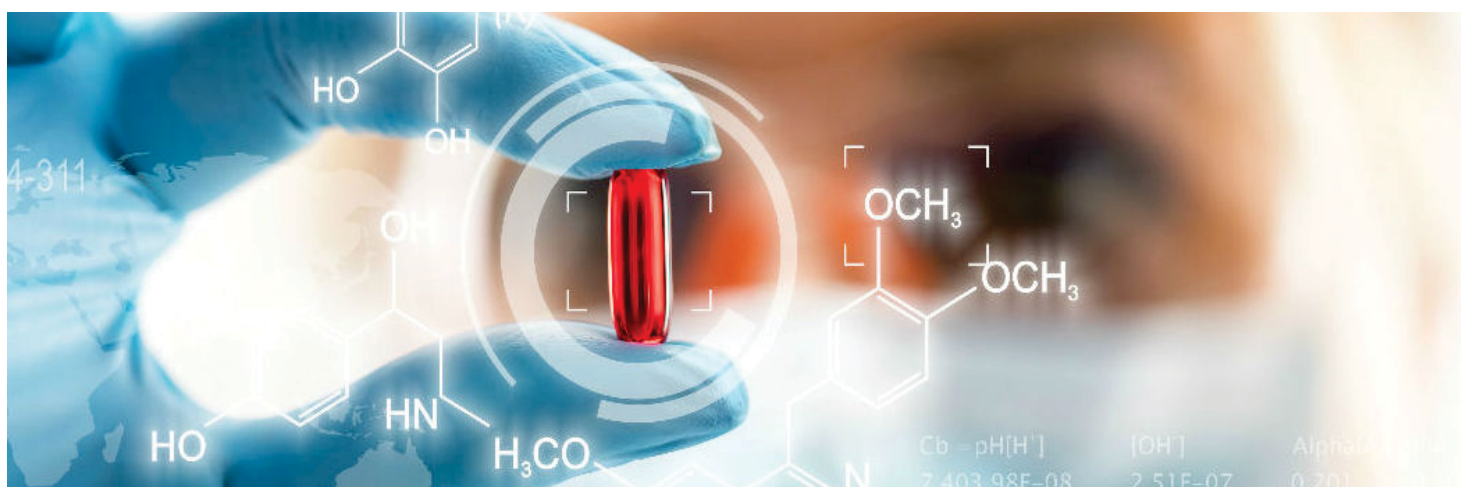



## PROGRAMME STRUCTURE

### (Semester-I)

Human Anatomy and Physiology I – Theory  
 Pharmaceutical Analysis I  
 Pharmaceutics I  
 Pharmaceutical Inorganic Chemistry – Theory  
 Communication skills – Theory  
 Remedial Biology/  
 Remedial Mathematics – Theory  
 Human Anatomy and Physiology – Practical  
 Pharmaceutical Analysis I – Practical  
 Pharmaceutics I – Practical  
 Pharmaceutical Inorganic Chemistry – Practical  
 Communication skills – Practical  
 Remedial Biology – Practical\*

### Semester-II

Human Anatomy and Physiology II – Theory  
 Pharmaceutical Organic Chemistry I – Theory 3  
 Biochemistry – Theory  
 Pathophysiology – Theory  
 Computer Applications in Pharmacy – Theory \*  
 Environmental sciences – Theory \*  
 Human Anatomy and Physiology II – Practical  
 Pharmaceutical Organic Chemistry I – Practical 4  
 Biochemistry – Practical 4  
 Computer Applications in Pharmacy – Practical\*

## Bachelor of Pharmacy (B.Pharm)

### PROGRAM OVERVIEW:

Bachelor of Pharmacy (B.Pharm) is an undergraduate degree course in the field of Pharmacy education. The students those are interested in the medical field (except to become a doctor) can choose this course after the completion of class 12th (PCM/B). After the completion of this degree, the students can practice as a Pharmacist. Pharmacists can work in a range of industries related to the prescription, manufacture & provision of medicines. The duration of this course is 4 years.

The B.Pharm is one of the popular job oriented course among the science students after class 12th. In this course the students study about the drugs and medicines, Pharmaceutical Engineering, Medicinal Chemistry etc. This course provides a large no. of job opportunities in both the public and private sector.

### Eligibility:

Students who want to join the B.Pharm programme have to fulfill the given eligibility criteria:

For admission to the Pharmacy courses, student must have passed class 12th with Physics, Chemistry & Mathematics/Biology.

Students have to secure a minimum of 50% marks in the qualifying examination.

Students, those pass the three year Diploma in Pharmacy (D.Pharm) are also eligible.

# Bachelor of Pharmacy(B.Pharma) Programme Structure

## Semester-III

Pharmaceutical Organic Chemistry II – Theory  
Physical Pharmaceutics I Theory  
Pharmaceutical Microbiology – Theory  
Pharmaceutical Engineering – Theory  
Pharmaceutical Organic Chemistry II – Practical  
Physical Pharmaceutics I Practical  
Pharmaceutical Microbiology – Practical  
Pharmaceutical Engineering –Practical

## Semester-IV

Pharmaceutical Organic Chemistry III– Theory  
Medicinal Chemistry I Theory  
Physical Pharmaceutics II Theory  
Pharmacology I Theory  
Pharmacognosy and Phytochemistry I– Theory  
Medicinal Chemistry I – Practical  
Physical Pharmaceutics II Practical  
Pharmacology I – Practical  
Pharmacognosy and Phytochemistry I – Practical

## Semester-V

Medicinal Chemistry II – Theory  
Industrial Pharmacy– Theory  
Pharmacology II – Theory  
Pharmacognosy and Phytochemistry II– Theory  
Pharmaceutical Jurisprudence – Theory  
Industrial PharmacyI – Practical  
Pharmacology II – Practical  
Pharmacognosy and Phytochemistry II – Practical

## Semester-VI

Medicinal Chemistry III – Theory  
Pharmacology III – Theory  
Herbal Drug Technology – Theory  
Biopharmaceutics and Pharmacokinetics – Theory  
Pharmaceutical Biotechnology – Theory  
Quality Assurance Theory  
Medicinal chemistry III – Practical  
Pharmacology III – Practical  
Herbal Drug Technology – Practical

## Semester-VII

Medicinal Chemistry III – Theory  
Pharmacology III – Theory  
Herbal Drug Technology – Theory  
Biopharmaceutics and Pharmacokinetics – Theory  
Pharmaceutical Biotechnology – Theory  
Quality Assurance Theory  
Medicinal chemistry III – Practical  
Pharmacology III – Practical  
Herbal Drug Technology – Practical

## Semester-VIII

Biostatistics and Research Methodology  
Social and Preventive Pharmacy  
Pharma Marketing Management  
Pharmaceutical Regulatory Science  
Pharmacovigilance  
Quality Control and Standardization of Herbals  
Computer Aided Drug Design  
Cell and Molecular Biology  
Cosmetic Science  
Experimental Pharmacology  
Advanced Instrumentation Techniques  
Dietary Supplements and Nutraceuticals  
Project Work



## PROGRAMME STRUCTURE

### (Year-1)

Pharmaceutics –Theory  
 Pharmaceutics –Practical  
 Pharmaceutical  
 Chemistry – Theory  
 Pharmaceutical  
 Chemistry –Practical  
 Pharmacognosy –Theory  
 Pharmacognosy –Practical  
 Human Anatomy &  
 Physiology –Theory  
 Human Anatomy &  
 Physiology –Practical  
 Social Pharmacy –Theory  
 Social Pharmacy –Practical

### (Year-2)

Pharmacology –Theory  
 Pharmacology –Practical  
 Community Pharmacy  
 & Management –Theory  
 Community Pharmacy  
 & Management –Practical  
 Biochemistry & Clinical  
 Pathology – Theory  
 Biochemistry & Clinical  
 Pathology – Practical  
 Pharmacotherapeutics– Theory  
 Pharmacotherapeutics– Practical  
 Hospital & Clinical  
 Pharmacy – Theory  
 Hospital & Clinical  
 Pharmacy – Practical  
 Pharmacy Law & Ethics



## Diploma in Pharmacy (D.Pharma)

### PROGRAM OVERVIEW:

Diploma in Pharmacy is a short-range course for aspirants who want to start their career in the field of pharmacy. Instead of doing long term courses in pharmacy domain, D. Pharmacy course is the ideal choice for the student who wants a quick start in their pharmacy career. Pursuing D. Pharm can be a good beginning to understand the fundamentals of pharmacy programme and then pursue advanced courses like B. Pharm .

Diploma in Pharmacy covers fundamental Pharmacy Education including the application of chemistry in the pharma industry, theoretical & practical concepts of biochemistry, pharmacology and toxicology. The course enables the students to study about different chemical salts, their application and uses in medicine. The programme holds fine significance in the pharmaceutical industry..

### Eligibility:

Students who want to join the D.Pharma programme have to fulfill the given eligibility criteria:

For admission to the Pharmacy courses, student must have passed class 12th with Physics, Chemistry & Mathematics/Biology.

Students have to secure a minimum of 50% marks in the qualifying examination.



**INDIAN NURSING COUNCIL**



**M.SC. Nursing**  
**B.SC. Nursing**  
**G.N.M. Nursing**  
**P.B.SC. Nursing**



GOVERNMENT OF MEGHALAYA  
OFFICE OF THE DIRECTOR OF HEALTH SERVICES (MH)  
MEGHALAYA::SHILLONG

ADVERTISEMENT FOR GENERAL NURSING & MIDWIFERY (GNM)  
TRAINING SESSION 2018-19

## What is Nursing

The field of medicine is one field that will continue to exist forever. Medicine is a need for humankind. Healthcare is a basic necessity. Similarly, in the field of medicine, nurses are the backbones of the entire sector.

There are various courses available for nursing. From diploma studies to postgraduate studies, the students have opportunities across various stages. Nursing is a career that most individuals opt for. It provides an opportunity for people to work with the health sector and help and serve people in need.

Nursing professionals play a prominent role across hospitals and healthcare sectors. They act as the link between patients and doctors. Doctors don't perform all duties; nurses perform pre and post-operation procedures. They also assist doctors in various operations and operations. They update charts and look after the patients.

The demand for quality of healthcare has been increasing over the years. Nursing students are given sufficient practical training during their course. They are trained to deal with problematic and high-risk cases.





## Eligibility Criteria/Admission

Requirements:

1. The candidate should be a Registered Nurse and Registered midwife or equivalent with any State Nursing Registration Council.
2. The minimum education requirements shall be the passing of :  
B.Sc. Nursing / B.Sc. Hons. Nursing / Post Basic B.Sc. Nursing with minimum of 55% aggregate marks.
3. The candidate should have undergone in B.Sc. Nursing / B.Sc. Hons. Nursing / Post Basic B.Sc. Nursing in an institution which is recognized by Indian Nursing Council.
4. Minimum one year of work experience after Basic B.Sc. Nursing.
5. Minimum one year of work experience prior or after Post Basic B.Sc. Nursing.
6. Candidate shall be medically fit.
7. 5% relaxation of marks for SC/ST candidates may be given.

## M.Sc. Nursing Specialisations

1. Medical and Surgical Nursing.
2. Gynecology and Obstetrics Nursing.
3. Paediatric Nursing.
4. Neuroscience and Mental Health Nursing.
5. Psychiatric Nursing
6. Critical Care Nursing
7. Oncological Nursing
8. Neonatal Infant and Newborn Nursing
9. Nephrological Nursing

## PROGRAMME STRUCTURE

### (Year-1)

Nursing education  
Advance nursing practice  
Nursing Research and statistics  
\*Clinical speciality –I

### (Year-2)

Nursing Management  
Nursing Research(Dissertation)  
\*Clinical Speciality-II



## M.Sc. Nursing

### PROGRAM OVERVIEW:

#### Indian Nursing Council believes that:

Post Graduate programme is essential to prepare nurses to improve the quality of nursing education and practice in India. . Post graduate programme in nursing builds upon and extends competence acquired at the graduate levels, emphasizes application of relevant theories into nursing practice, education, administration and development of research skills.

The programme prepares nurses for leadership position in nursing and health fields who can function as nurse specialists, consultants, educators, administrators and researchers in a wide variety of professional settings in meeting the National priorities and the changing needs of the society.

### Duration

Duration of the course is 2 years for M.Sc. (N)  
Available 52 weeks  
Vacation 4 weeks  
Examination 2 weeks  
Gazetted holidays 3 weeks  
Total weeks available 43 weeks  
40 hours per week 1720 hours  
Total hours for 2 years 3440 hours

# Bachelor of Science in Nursing(B.Sc.Nursing)

## PROGRAMME OVERVIEW

We believe that,

Health is a state of well- being that enables a person to lead a psychologically, socially and economically productive life. Health is a right of all the people. Individuals, families and communities have a responsibility towards maintaining their health.

Nursing contributes to the health services in a vital and significant way in the health care delivery system. It recognizes national health goals and is committed to participate in the implementation of National Health Policies and programmes. It aims at identifying health needs of the people, planning and providing quality care in collaboration with other health professional and community groups.

Scope of nursing practice encompasses provision of promotive, preventive, curative and rehabilitative aspects of care to people across their life span in wide variety of health care settings. Practice of nursing is based upon application of basic concepts and principles derived from the physical, biological and behavioural sciences, medicine and nursing.

Nursing is based on values of caring, and aims to

## ELIGIBILITY FOR ADMISSION

An equivalent with 12 years schooling from a recognized board or university with minimum of 45 % aggregate marks (40% marks for SC, ST, for MBC, OBC candidates in part – III subjects of Physics, Chemistry & Biology / Botany & Zoology) and should have English as one of the subject

## DURATION OF THE PROGRAMME

The period of certified study and training of the B.Sc. Nursing Degree course shall be of four academic years including internship



## PROGRAMME STRUCTURE

### (Year-I)

- 1 English
2. Anatomy
3. Physiology
4. Nutrition
5. Biochemistry
6. Nursing Foundations
7. Psychology
8. Microbiology
9. Introduction to computers
10. Regional Language
10. Library Work /Self Study
11. Co-curricular activities

### (Year-II)

- 1 Sociology
2. Pharmacology
3. Pathology
4. Genetics
5. Medical-Surgical Nursing (Adult including Geriatrics)-I
6. Community Health Nursing
7. Communication and Educational Technology
8. Library Work / Self Study
9. Co-curricular activities

### (Year-III)

1. Medical Surgical Nursing - II (Adult including Geriatrics)
2. Child Health Nursing
3. Mental Health Nursing
4. Nursing Research & Statistics
5. Library Work / Self Study
- 6 Co-curricular activities

### (Year-IV)

1. Midwifery and Obstetrical Nursing. Community Health Nursing – II Including the concept of Middle Level Health Provider (MLHP)
3. Management of Nursing Services and Education



## G.N.M. (NURSING)

### PROGRAMME STRUCTURE

#### (Year-I)

Bio Sciences  
 - Anatomy & Physiology.  
 - Microbiology  
 Behavioral Sciences  
 - Psychology  
 - Sociology  
 Nursing Foundations  
 - Fundamentals of Nursing.  
 - First aid  
 Community Health Nursing  
 - Environmental Hygiene  
 - Health Education &  
 Communication Skills  
 - Nutrition  
 English  
 Computer Education  
 Co-curricular activities

#### (Year-II)

Medical Surgical Nursing-I  
 Medical Surgical Nursing -II  
 Mental Health Nursing  
 Child Health Nursing  
 Co-curricular activities  
 Midwifery & Gynaecological  
 Nursing  
 Community Health Nursing-II  
 Co-curricular  
 Nursing Education  
 Introduction to Research and  
 statistics  
 Professional Trends &  
 Adjustments.  
 Nursing Administration & Ward  
 Management  
 Medical Surgical Nursing  
 Community Health Nursing  
 Child Health Nursing  
 Midwifery and Gynaecological  
 Nursing  
 Mental Health Nursing



## Diploma in General Nursing & Midwifery

### PROGRAMME OVERVIEW:

Full Form of GNM is General Nursing and Midwifery. GNM Nursing is a diploma level course with a duration of 3 years 6 months. GNM Syllabus consists of 3 years of education and 6 months of internship that is mandatory. General Nursing and Midwifery course details focus on providing skills and knowledge related to patient care and clinical treatment.

GNM Nursing eligibility is that students after completing class 12 can apply for this course. Students that have studied biology in class 11-12 are given extra preference. GNM Nursing admission process takes place through various state level entrance exams such as WB GNM, Kerala GNM, Maharashtra GNM etc. GNM Nursing Qualification is to pass the entrance exams and get admission in the required college.

### Duration

1. Minimum education eligibility criteria for admission to GNM:

- 10+2 with English and must have obtained a minimum of 40% at the qualifying examination and English individually from any recognized board. Candidates are also eligible from State Open School recognized by State Government and National Institute of Open School (NIOS) recognized by Central Government. However Science is preferable.
- 10+2 with English having 40% of marks in vocational ANM course from the school recognized by Indian Nursing Council
- 10+2 with English having 40% of marks in Vocational Stream-Health care Science from a recognized CBSE board/State/Centre
- Registered ANM with pass mark.



Application Form No.

Roll Number   
(for office use only)

## ATE GROUP OF INSTITUTIONS

### CHOICE OF COURSE

1. Candidate's Name in Capital letters as given in class X Certificate

2. Father's Name in Capital letters

3. Mather's Name in Capital letters

4. Sex : Male  Female

5. Date of Birth  
(As per class X Certificate)

Date    Month    Year

6. Category

GEN  ST   
 SC  OBC/EBC   
 Others

7. Place of Residence

Village   
 Town

8. School Board of Class XII    10a. % Mark Obtained in Class X (if passed)     11a. Year of passing/Appearing X

CBSE  State Board

ICSE  Others     10b. % Mark Obtained in Class XII (if passed)     11b. Year of passing/Appearing XII

12. Appeared/Appearing for

NEET   
 JEE   
 AIEEE   
 OTHER

13. Mode of Preparation

Self Study   
 Individual Tuton   
 Coaching   
 Correapondence   
 Course/Other

14. Choice of Examination Centre  
(Give two Option)

a. PATNA     g. MUZAFFARPUR   
 b. BHAGALPUR     h. RANCHI   
 c. BOKARO     i. JAMSHEDPUR   
 d. DELHI     j. LUCKNOW   
 e. BIHARSHARIF     k. PANIPAT   
 f. JAMMU     l. GUWAHATI   
 m. SHILLONG

15. E-mail ID

Affix your recent  
passport size  
colour photo

Candidate's Signature

**ADMIT CARD**

## ATE GROUP OF INSTITUTIONS

Application Form No.

Roll Number   
(for office use only)

Candidate's mailing address in CAPITAL LETTERS only

NAME.....

FATHER'S NAME.....

ADDRESS.....

.....P.O.....

DIST.....STATE.....

PINCODE          TEL. NO.....

Affix your recent  
passport size  
colour photo

Candidate's Signature

**16. Father's Education Qualification, Occupation and Annual Income**

Matric	<input type="checkbox"/>	Service	<input type="checkbox"/>	Annual Income	>1,00,000	<input type="checkbox"/>	Designation	<input type="text"/>
Inter	<input type="checkbox"/>	Business	<input type="checkbox"/>		>1,50,000	<input type="checkbox"/>		
Graduate	<input type="checkbox"/>	Other	<input type="checkbox"/>		>2,00,000	<input type="checkbox"/>		
Other	<input type="checkbox"/>				>2,50,000 & above	<input type="checkbox"/>		

D.D. No.	ISSUE DATE	BANK NAME	AMOUNT

**Candidate's mailing address in CAPITAL LETTERS only**

(To be filled by student)

NAME.....

FATHER'S NAME.....

ADDRESS.....

.....P.O.....

DIST.....STATE.....

PINCODE  TEL. NO.....

**DECLARATION**

I hereby solemnly and sincerely affirm that all the particular stated by me in this Application Form are true and correct

PLACE.....

DATE.....

\_\_\_\_\_  
GUARDIAN'S SIGNATURE

\_\_\_\_\_  
CANDIDATE'S SIGNATURE

**On spot Admission-MBBS/BDS**  
**Lowest package Guranteed**

MBBS ABROAD  
Bangladesh  
Armenia  
kyroyzstan  
Ukraine  
Kazakhstan  
Uzbekistan

**now MBBS**  
**is in your**  
**BUDGET!!!**

**100%**  
**Admisssion**  
**Guarantee**

**MCI & WHO Approved**  
**"A" Grade Universities**

**No Large**  
**Fees Scale**

**Don't require high score in NEET (Only NEET Approved)**

**Only 50% in PCB (in 12th)**

	Course	Duration	Eligibility	University Fee	Consultancy fee
1.	Cms-ED	2-years	10th/12th	Rs 17,500P/Y	Rs 15000 P/Y
2.	B.N.Y.S	4 & 1/2-years	12th(PCB)	Rs 30000 P/S	Rs 15000 P/S
3.	D.N.Y.S	2-years	12th(PCB)	Rs 10000 P/S	Rs 5000 P/Y
4.	M.A. in Yoga	2-years	B.A. in yoga	Rs 35000p/y	Rs 15000p/y
5.	Certificate in Yoga	1-years	10th/12th	Rs 7500p/y	Rs 5000 p/y
6.	Yoga Teaher Training	2-years	10th/12th	Rs 7500p/y	Rs 7500p/y
7.	B.A. in Yoga	3-years	12th	Rs 10000p/y	Rs 5000p/y
8.	Diploma in yoga	2-years	12th	Rs 10000p/y	Rs 5000p/y
9.	M.pharmacy	2-years	B-pharmacy	Rs 50000p/s	Rs 15000p/s
10	B.Pharmacy	2-years	12th(pcb/pcm)	Rs 80000p/y	Rs 15000p/y
11	D.pharmacy	2-years	12th(pcb/pcm)	Rs 120000p/y	Rs 10000p/y
12	M.sc. Nursing	2-years	B.sc.Nursing	Rs 120000p/y	Rs 15000p/y
13	B.sc. Nursing	2-years	12th(pcb)	Rs 95000p/y	Rs 15000p/y
14	GNM Nursing	3 & 1/2-years	12th pass	Rs 65000p/y	Rs 15000p/y
15	ANM Nursing	1&1/2-years	12th pass	Rs 65000p/y	Rs 15000p/y
16	P.bsc. Nursing	2-years	GNM	Rs 70000p/y	Rs 15000p/y
17	MBBS India	4 & 1/2-years	As per neet score		Rs 300000 PROC.
18	MBBS Abroad	4 & 1/2-years	As per neet score		Rs 350000 PROC.
19	BAMS/BUMS/BHMS	4 & 1/2-years	As per neet score		Rs 150000 PROC.
20	M.Sc.( Medical Laboratory Technology)	2-years	B.sc.MLT	Rs 40000p/y	Rs 15000p/y
21	B.Sc.( Medical Laboratory Technology)	3-years	12th Science	Rs 20000p/y	Rs 15000p/y
22	Diploma.( Medical Laboratory Technology)	2/3-years	10th/12th	Rs 15000p/y	Rs 15000p/y
20	Certificate.( Medical Laboratory Technology)	1-years	10th	Rs15000p/y	Rs 15000p/y
21	M.sc.( Radiology & Imaging Technology)	2-years	BRIT	Rs 20000p/y	Rs 15000p/y
22	B.sc.( Radiology & Imaging Technology)	3-years	12th(pcb)	Rs 20000p/y	Rs 15000p/y
23	Diploma.( Radiology & Imaging Technology)	2-years	10th/12th	Rs 15000p/y	Rs 15000p/y
23	Certificate.( Radiology & Imaging Technology)	2-years	10th	Rs 15000p/y	Rs 15000p/y
23	Diploma.( Radiology & Imaging Technology)	2-years	10th/12th	Rs 15000p/y	Rs 15000p/y
23	M.sc.( Operation Theater Technology (Msc.OT)	2-years	B.sc.(O.T.)	Rs 40000p/y	Rs 15000p/y
24	B.sc.( Operation Theater Technology (B.sc.OT)	2-years	12th(pcb)	Rs 40000p/y	Rs 15000p/y
25	Diploma( Operation Theater Technology (D.OT)	2/3-years	12th(pcb)	Rs 15000p/y	Rs 15000p/y
26	Certificate( Operation Theater Technology (C.OT)	1-years	10th	Rs 15000p/y	Rs 15000p/y
25	Diploma( X-ray Technician)	2/3-years	10th/12th(pcb)	Rs 15000p/y	Rs 15000p/y
26	<b>Diploma in ( Ayurvedic Pharmacy )</b>	2-years	12th(pcb)	Rs 15000p/y	Rs 15000p/y
27	<b>Diploma in ( Dental Technology )</b>	2-years	12th(pcb)	Rs 15000p/y	Rs 15000p/y
28	<b>Diploma in ( Dialysis Technician )</b>	2-years	12th(pcb)	Rs 15000p/y	Rs 15000p/y
29	<b>Diploma in ( ECG Technician )</b>	2-years	12th(pcb)	Rs 15000p/y	Rs 15000p/y
30	<b>Diploma in (Health Care &amp; Services )</b>	2-years	12th(pcb)	Rs 15000p/y	Rs 15000p/y
31	<b>Diploma in (Medical Record Technology )</b>	2-years	12th(pcb)	Rs 15000p/y	Rs 15000p/y
32	<b>Diploma in (Medical Dresser )</b>	2-years	12th(pcb)	Rs 15000p/y	Rs 15000p/y
33	<b>Diploma in (Multipurpose Health Worker )</b>	2-years	12th(pcb)	Rs 15000p/y	Rs 15000p/y
34	<b>Diploma in (Nutrition &amp; Dietics )</b>	2-years	12th(pcb)	Rs 15000p/y	Rs 15000p/y
35	<b>Diploma in (Nutrition &amp; Dietics )</b>	2-years	12th(pcb)	Rs 15000p/y	Rs 15000p/y
36	<b>Diploma in (Optometry )</b>	2-years	12th(pcb)	Rs 15000p/y	Rs 15000p/y
37	<b>Diploma in (VeterinaryPharmacy )</b>	2-years	12th(pcb)	Rs 15000p/y	Rs 15000p/y
38	<b>Diploma in (CT Scan Technician )</b>	2-years	12th(pcb)	Rs 15000p/y	Rs 15000p/y
39	<b>Diploma in (EEG Technician )</b>	2-years	12th(pcb)	Rs 15000p/y	Rs 15000p/y
40	<b>Diploma in (Emergency Medical Technician )</b>	2-years	12th(pcb)	Rs 15000p/y	Rs 15000p/y
41	<b>Diploma in (Orthopedics )</b>	2-years	12th(pcb)	Rs 15000p/y	Rs 15000p/y

## Information Center

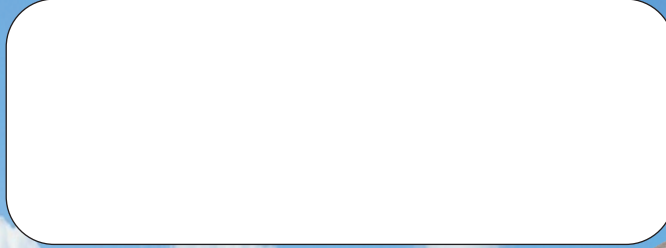

H.o.: F-321 2nd floor old m.b. Road ladosarai New Delhi-30